



VARLEY

H VARLEY LIMITED | HEALTHCARE APPLICATIONS | CATALOGUE HEA20



VARLEY

products for healthcare applications, selected from the full VARLEY catalogue



PRESSED STEEL CASTORS



FABRICATED STEEL CASTORS



SPECIAL APPLICATION CASTORS



HEALTHCARE APPLICATIONS



WHEELS



MATERIALS HANDLING



MISCELLANEOUS PRODUCTS



# introduction & contents



HEALTHCARE APPLICATIONS

H VARLEY has specialised in supplying the UK castor market since 1938, offering our customers the stability and strength they require. Our success has been achieved in responding to our customers' needs by offering:

## Service and Support

A huge range of stock at our Altrincham warehouse and, at each of our locations, technical field sales representatives supported by knowledgeable and experienced sales office personnel. Our friendly and helpful staff will make sure your requirements are met accurately and rapidly with a next day delivery or same day trade counter collection.

## Quality

H Varley takes pride in offering only the best quality products from the world's leading castor and wheel manufacturers to make certain our customers are consistently supplied with dependable, quality products to ISO 9001:2015.

## Specification

We are continually exploring and developing our product ranges. By working closely with our suppliers and analysing market trends and requirements we endeavour to keep our customers informed and at the forefront of new technology and design with new product options available into both new and existing market places.

## Market Prices

Price requirements are constantly monitored and reviewed with our suppliers to ensure our customers are consistently supplied at competitive market prices.



Based around the Manner **TANGO** range, products ideally suited to the healthcare industry selected from the full VARLEY catalogue. The Healthcare Applications range offers price competitive, quality assured products with off the shelf availability.

## Specification and product selection

- All catalogue dimensions are in millimetres unless otherwise stated.
- All catalogue load ratings are in kilogrammes unless otherwise stated.

Load ratings given are based on intermittent use on normal truck and trolley applications. Special conditions may apply under any of the following applications or hazards:

- Uneven floor surface
- Ramps, cracks, gullies, door guide rails
- Track or turntable use
- Power towing or driven wheels or rollers
- Any application other than manually propelled truck and trolley use

It may be appropriate to select a castor or wheel with a load capacity much greater than would appear necessary in a given set of circumstances, please ask our technical sales team for assistance in product selection.

Specifications (by dimension, description, illustration or otherwise) may be approximate and liable to change without notice, especially with regard to developments and improvements.

Listing of goods does not necessarily imply that they are ex-stock, nor do we accept any obligation to supply them.













All recommendations are given to the best of our knowledge and ability. No liability is accepted for their application.

Please refer to our Technical Information publication for more details.



HEAD OFFICE & WAREHOUSE: 5 CENTURY PARK PACIFIC ROAD BROADHEATH ALTRINCHAM CHESHIRE WA14 5BJ t: 0161 928 9617 f: 0161 928 7824 e: SALES@VARLEY.CO.UK  
SCOTLAND, NORTH EAST t: 01698 732523 f: 01698 730947 e: SCOTSALES@VARLEY.CO.UK MIDLANDS, SOUTH t: 01952 462527 f: 01952 460176 e: MIDSALSALES@VARLEY.CO.UK



	<b>TANGO</b>	<b>2</b>
	Key features	
	<b>GKL</b>	<b>3</b>
<b>PRESSED STEEL CASTORS</b>	Tango castors, plate fixing	
	<b>GK</b>	<b>4</b>
	Tango castors, single hole fixing	
	<b>GKR</b>	<b>5</b>
<b>FABRICATED STEEL CASTORS</b>	Tango castors, bolt fixing	
	<b>GKT</b>	<b>6</b>
	Tango castors, expander fixing	
	<b>GKL AX</b>	<b>7</b>
<b>SPECIAL APPLICATION CASTORS</b>	Tango castors, plate fixing, anti-static	
	<b>GK AX</b>	<b>8</b>
<b>HEALTHCARE APPLICATIONS</b>	Tango castors, single hole fixing, anti-static	
	<b>GKR AX</b>	<b>8</b>
	Tango castors, bolt fixing, anti-static	
	<b>HB</b>	<b>9</b>
<b>WHEELS</b>	Tango castors with hand brake system	
	<b>e-SMART</b>	<b>9</b>
	Remote locking and braking system	
	<b>V10V</b>	<b>10</b>
<b>MATERIALS HANDLING</b>	Stretcher castors	
	<b>INDEX</b>	<b>11</b>
<b>MISCELLANEOUS PRODUCTS</b>	<b>OTHER PRODUCTS</b>	<b>12</b>
	<b>PREFERRED RANGE</b>	

MANNER is a Finnish, family owned company founded in 1890. Today Manner is the leading castor manufacturer in the Nordic countries.

Manner castors are internationally known and recognised as having a proud reputation for quality of design and manufacture. Their knowledge of plastics and precision engineering, combined with progressive product development and awareness of customer requirements guarantees the ability to manufacture high quality, durable castors and wheels.



The **TANGO** series is a proven castor with outstanding success rehab, medical and catering equipment providing user benefits in performance and visual appearance.

The contemporary design in itself gives a new look and feel to any chosen application, while the curved shapes of the frame increase its load capacity, strength and stability while allowing the castor to be easily cleaned.

The **TANGO** castor is available with a number of options such as total stop brake, directional lock, anti-static and stainless



variations. Manner also have the ability and flexibility to tailor castors for equipment manufacturers' specific requirements. A



larger brake pedal is available to order where an application demands, and ensures safe use while protecting the wheel from dirt. The standard finish for castor frames is mid-grey (dark grey for anti-static castors) but light grey and black are also available. For larger quantity orders Manner can customise the colour of brake pedals and threadguards and pedals can even feature your brand logo! Equipment manufacturers may also benefit from the option of plastic wrap on the wheel tread to protect tyres while in transit.



- 1** Select from plate, bolt hole, bolt fixing (illustrated) or expanding adaptor for tube.
- 2** Precision ball-bearing swivel head with labyrinth seal. Non-corroding, glass fibre reinforced polyamide housing.
- 3\*** Brake pedal operates within swept radius (100mm and 125mm diameter).
- 4** Total lock of wheel and swivel action. Also available with directional lock for straight line travel. Ergonomic press to engage, press to release pedal.
- 5** Non-marking tread.
- 6** Smooth contours and service-free design make castor easy to clean.



\* Swept radius is calculated as the castor's swivel offset (as detailed within data tables on the following pages) + wheel radius. The operating pedal on 75mm castors with brake or directional lock increases this figure by 21mm.

## GKL | PTE | PLATE FIXING

GREY THERMOELASTIC RUBBER TYRED WHEEL WITH POLYPROPYLENE CENTRE

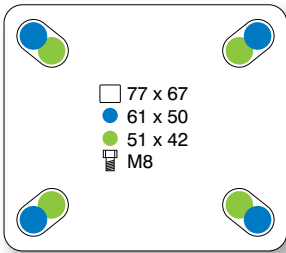

- 77 x 67
- 61 x 50
- 51 x 42
- M8

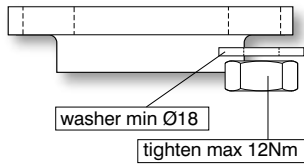

wheel diameter	tread width	fitted height	swivel offset	shore A	load capacity	bearing type	swivel	fixed	swivel + total-stop brake	swivel + directional lock
75	32	117	35.5	80	70	ball	<a href="#">GKL-S-75 PTE/K 80-G2</a>		<a href="#">GKL-J-S-75 PTE/K 80-G2</a>	<a href="#">GKL-R-S-75 PTE/K 80-G2</a>
100	32	148	45	80	100	ball	<a href="#">GKL-S-100 PTE/K 80</a>	<a href="#">GPL-S-100 PTE/K 80</a>	<a href="#">GKL-J-S-100 PTE/K 80</a>	<a href="#">GKL-R-S-100 PTE/K 80</a>
125	32	168	44.5	80	100	ball	<a href="#">GKL-S-125 PTE/K 80</a>	<a href="#">GPL-S-125 PTE/K 80</a>	<a href="#">GKL-J-S-125 PTE/K 80</a>	<a href="#">GKL-R-S-125 PTE/K 80</a>



STAINLESS STEEL. All metal components including swivel head and wheel bearings  
Available on all 100, 125 diameter castors  
Add **-IX** to castor reference

**i** All dimensions are in **mm** and all loadings are in **kg** unless otherwise stated

## GK | PTE | SINGLE HOLE FIXING

GREY THERMOELASTIC RUBBER TYRED WHEEL WITH POLYPROPYLENE CENTRE

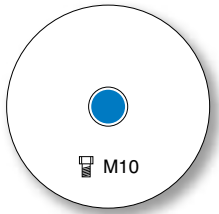

wheel diameter	tread width	fitted height	swivel offset	shore A	load capacity	bearing type	swivel	fixed	swivel + total-stop brake	swivel + directional lock
75	32	110	35.5	80	70	ball	<a href="#">GK-S-75 PTE/K 80-G2</a>		<a href="#">GK-J-S-75 PTE/K 80-G2</a>	
100	32	141	45	80	100	ball	<a href="#">GK-S-100 PTE/K 80</a>		<a href="#">GK-J-S-100 PTE/K 80</a>	
125	32	161	44.5	80	100	ball	<a href="#">GK-S-125 PTE/K 80</a>		<a href="#">GK-J-S-125 PTE/K 80</a>	

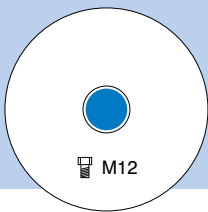

### ALTERNATIVE HOLE SIZE

Access is restricted. It is therefore recommended to fit bolt from above with nut and washer underneath the swivel head

Add **-12** to castor reference



**BUFFER.** 90mm diameter thermoplastic rubber with polypropylene centre. Prevents damage to equipment and fabric of building

Fitted height increased by 5mm

Add **-BU** to castor reference



**STAINLESS STEEL.** All metal components including swivel head and wheel bearings

Available on all 100, 125 diameter castors

Add **-IX** to castor reference



**NON-MAGNETIC**

Available on all 100, 125 diameter castors

Add **-NM H** to castor reference

**i** All dimensions are in **mm** and all loadings are in **kg** unless otherwise stated

## GKR | PTE | BOLT FIXING

GREY THERMOELASTIC RUBBER TYRED WHEEL WITH POLYPROPYLENE CENTRE

**i** Total stop castors: red pedal  
Directional lock castors: dark grey pedal

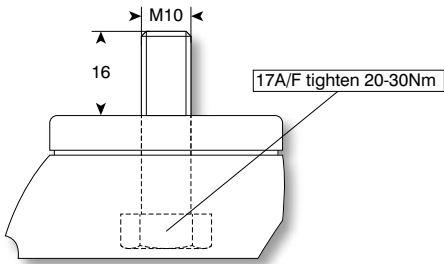

wheel diameter	tread width	fitted height	swivel offset	shore A	load capacity	bearing type	swivel	fixed	swivel + total-stop brake	swivel + directional lock
75	32	110	35.5	80	70	ball	GKR-S-75 PTE/K 80-G2		GKR-J-S-75 PTE/K 80-G2	GKR-R-S-75 PTE/K 80-G2
100	32	141	45	80	100	ball	GKR-S-100 PTE/K 80	GPR-S-100 PTE/K 80	GKR-J-S-100 PTE/K 80	GKR-R-S-100 PTE/K 80
125	32	161	44.5	80	100	ball	GKR-S-125 PTE/K 80	GPR-S-125 PTE/K 80	GKR-J-S-125 PTE/K 80	GKR-R-S-125 PTE/K 80

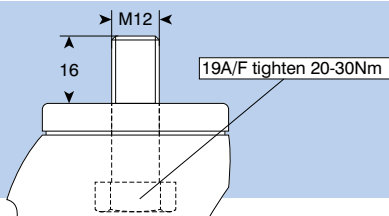

### ALTERNATIVE BOLT SIZE

Available on all swivel castors  
Add **M12** to castor reference



**BUFFER.** 90mm diameter thermoplastic rubber with polypropylene centre. Prevents damage to equipment and fabric of building

Fitted height increased by 5mm  
Add **-BU** to castor reference



**STAINLESS STEEL.** All metal components including swivel head and wheel bearings  
Available on all 100, 125 diameter castors  
Add **-IX** to castor reference



**NON-MAGNETIC**  
Available on all 100, 125 diameter castors  
Add **-NM H** to castor reference

**i** All dimensions are in **mm** and all loadings are in **kg** unless otherwise stated

## GKT | PTE | EXPANDER FIXING

GREY THERMOELASTIC RUBBER TYRED WHEEL WITH POLYPROPYLENE CENTRE

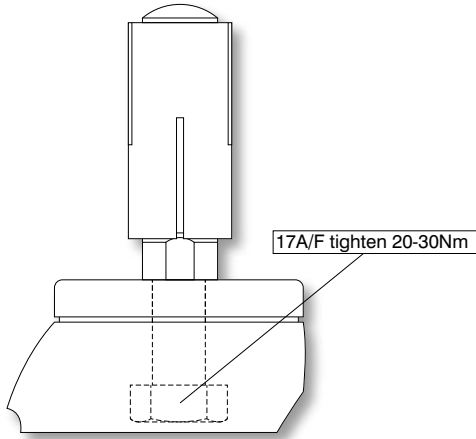

wheel diameter	tread width	fitted height	swivel offset	shore A	load capacity	bearing type	swivel	fixed	swivel + total-stop brake	swivel + directional lock
75	32	110	35.5	80	70	ball	GKT-S-75 PTE/K 80-G2		GKT-J-S-75 PTE/K 80-G2	
100	32	141	45	80	100	ball	GKT-S-100 PTE/K 80		GKT-J-S-100 PTE/K 80	
125	32	161	44.5	80	100	ball	GKT-S-125 PTE/K 80		GKT-J-S-125 PTE/K 80	

### Expander sizes (add to castor reference)

internal size of tube	round	square
17		GKT-17X17
18	GKT-18	
22	GKT-22	GKT-22X22
25	GKT-25	
27		GKT-27X27
28	GKT-28	
37	GKT-37	GKT-37X37



**STAINLESS STEEL.** All metal components including swivel head and wheel bearings  
Available on all 100, 125 diameter castors  
Add **-IX** to castor reference



**BUFFER.** 90mm diameter thermoplastic rubber with polypropylene centre. Prevents damage to equipment and fabric of building  
Fitted height increased by 5mm  
Add **-BU** to castor reference

**i** All dimensions are in **mm** and all loadings are in **kg** unless otherwise stated



## GKL | PTE AX | PLATE FIXING

ANTI-STATIC GREY THERMOELASTIC RUBBER TYRED WHEEL WITH POLYPROPYLENE CENTRE

**i** Total stop castors: yellow pedal  
Directional lock castors: dark grey pedal

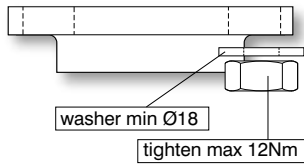
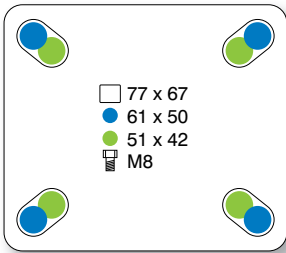

wheel diameter	tread width	fitted height	swivel offset	shore A	load capacity	bearing type	swivel	fixed	swivel + total-stop brake	swivel + directional lock
75	32	117	35.5	86	70	ball	<a href="#">GKL-S-75 PTE/K A</a>		<a href="#">GKL-JY-S-75 PTE/K A</a>	<a href="#">GKL-R-S-75 PTE/K A</a>
100	32	148	45	86	100	ball	<a href="#">GKL-S-100 PTE/K AX</a>		<a href="#">GKL-JY-S-100 PTE/K AX</a>	<a href="#">GKL-R-S-100 PTE/K AX</a>
125	32	168	44.5	86	100	ball	<a href="#">GKL-S-125 PTE/K AX</a>		<a href="#">GKL-JY-S-125 PTE/K AX</a>	<a href="#">GKL-R-S-125 PTE/K AX</a>

**i** All dimensions are in **mm** and all loadings are in **kg** unless otherwise stated

## GK | PTE AX | SINGLE HOLE FIXING

ANTI-STATIC GREY THERMOELASTIC RUBBER TYRED WHEEL WITH POLYPROPYLENE CENTRE

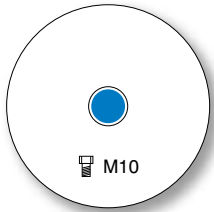

wheel diameter	tread width	fitted height	swivel offset	shore A	load capacity	bearing type	swivel	fixed	swivel + total-stop brake	swivel + directional lock
75	32	110	35.5	86	70	ball	GK-S-75 PTE/K A		GK-JY-S-75 PTE/K A	
100	32	141	45	86	100	ball	GK-S-100 PTE/K AX		GK-JY-S-100 PTE/K AX	
125	32	161	44.5	86	100	ball	GK-S-125 PTE/K AX		GK-JY-S-125 PTE/K AX	

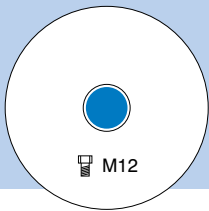

### ALTERNATIVE HOLE SIZE

Available on all castors

Access is restricted. It is therefore recommended to fit bolt from above with nut and washer underneath the swivel head

Add -12 to castor reference

## GKR | PTE AX | BOLT FIXING

ANTI-STATIC GREY THERMOELASTIC RUBBER TYRED WHEEL WITH POLYPROPYLENE CENTRE

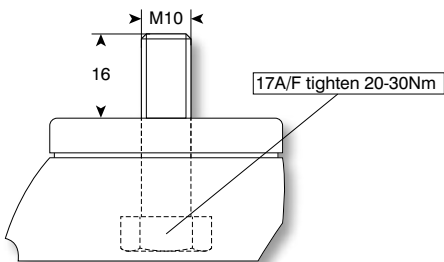

**i** Total stop castors: yellow pedal  
Directional lock castors: dark grey pedal



wheel diameter	tread width	fitted height	swivel offset	shore A	load capacity	bearing type	swivel	fixed	swivel + total-stop brake	swivel + directional lock
75	32	110	35.5	86	70	ball	GKR-S-75 PTE/K A		GKR-JY-S-75 PTE/K A	GKR-R-S-75 PTE/K A
100	32	141	45	86	100	ball	GKR-S-100 PTE/K AX		GKR-JY-S-100 PTE/K AX	GKR-R-S-100 PTE/K AX
125	32	161	44.5	86	100	ball	GKR-S-125 PTE/K AX		GKR-JY-S-125 PTE/K AX	GKR-R-S-125 PTE/K AX

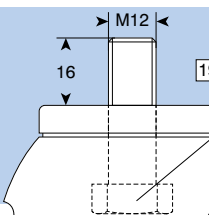

### ALTERNATIVE BOLT SIZE

Available on all castors

Add M12 to castor reference

**i** All dimensions are in mm and all loadings are in kg unless otherwise stated

# HB

TANGO CASTORS | HAND BRAKE SYSTEM



HEALTHCARE APPLICATIONS

The hand brake for **TANGO** castors has been designed to meet the requests of mobility aid device users who would like to have the braking and locking control of the castors in their hand.



The hand brake solution incorporates an easy to install mounting solution into a tube frame. The tube attachment is custom designed to meet the customer's own tube frame design.

Please ask for further details

# e-SMART

TANGO CASTORS | REMOTE LOCKING AND BRAKING SYSTEM



HEALTHCARE APPLICATIONS

The superb ergonomics and safety features of the Manner **e-SMART** castor locking system improve and facilitate work in the field of medical care and rehabilitation and wherever central locking castors are needed.



The **e-SMART** offers remote, pedal-free activation of total-stop brakes and directional locks. Maintenance-free castors ensure long life and high usability while special ball bearings ensure easy and reliable operation.

Please ask for an **e-SMART** specialist to get in touch



Ergonomic and efficient to use with a hand controller. Eliminates unnecessary movements such as stretching and pressing of footbrakes thus reducing the risk of injury at work

The clever castor attachment enables lightweight and impressive equipment design.



## V10V | MC | SINGLE HOLE FIXING

GREY CLOSED CELL MICROCELLULAR POLYURETHANE TYRE, POLYPROPYLENE CENTRE

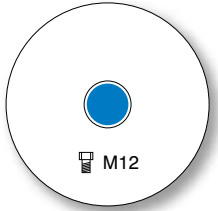

wheel diameter	tread width	fitted height	swivel offset	load capacity	bearing type	swivel	fixed	swivel + total-stop brake
200	49	234	48	150	ball	V10V 200 MCJ B12		V12V 200 MCJ B12

**i** All dimensions are in **mm** and all loadings are in **kg** unless otherwise stated



GK-J-S-100 PTE/K 55	4	GKR-S-125 PTE/K 55	5
GK-J-S-100 PTE/K 80	4	GKR-S-125 PTE/K 80	5
GK-J-S-125 PTE/K 55	4	GKR-S-125 PTE/K AX	8
GK-J-S-125 PTE/K 80	4	GKR-S-75 PTE/K 80-G2	5
GK-J-S-75 PTE/K 80-G2	4	GKR-S-75 PTE/K A	8
GK-JY-S-100 PTE/K AX	8	GKT-J-S-100 PTE/K 55	6
GK-JY-S-125 PTE/K AX	8	GKT-J-S-100 PTE/K 80	6
GK-JY-S-75 PTE/K A	8	GKT-J-S-125 PTE/K 55	6
GK-S-100 PTE/K 55	4	GKT-J-S-125 PTE/K 80	6
GK-S-100 PTE/K 80	4	GKT-J-S-75 PTE/K 80-G2	6
GK-S-100 PTE/K AX	8	GKT-S-100 PTE/K 55	6
GK-S-125 PTE/K 55	4	GKT-S-100 PTE/K 80	6
GK-S-125 PTE/K 80	4	GKT-S-125 PTE/K 55	6
GK-S-125 PTE/K AX	8	GKT-S-125 PTE/K 80	6
GK-S-75 PTE/K 80-G2	4	GKT-S-75 PTE/K 80-G2	6
GK-S-75 PTE/K A	8	GPL-S-100 PTE/K 55	3
GKL-J-S-100 PTE/K 55	3	GPL-S-100 PTE/K 80	3
GKL-J-S-100 PTE/K 80	3	GPL-S-125 PTE/K 55	3
GKL-J-S-125 PTE/K 55	3	GPL-S-125 PTE/K 80	3
GKL-J-S-125 PTE/K 80	3	GPR-S-100 PTE/K 55	5
GKL-J-S-75 PTE/K 80-G2	3	GPR-S-100 PTE/K 80	5
GKL-JY-S-100 PTE/K AX	7	GPR-S-125 PTE/K 55	5
GKL-JY-S-125 PTE/K AX	7	GPR-S-125 PTE/K 80	5
GKL-JY-S-75 PTE/K A	7	V10V 200 MCJ B12	10
GKL-R-S-100 PTE/K 55	3	V12V 200 MCJ B12	10
GKL-R-S-100 PTE/K 80	3		
GKL-R-S-100 PTE/K AX	7		
GKL-R-S-125 PTE/K 55	3		
GKL-R-S-125 PTE/K 80	3		
GKL-R-S-125 PTE/K AX	7		
GKL-R-S-75 PTE/K 80-G2	3		
GKL-R-S-75 PTE/K A	7		
GKL-S-100 PTE/K 55	3		
GKL-S-100 PTE/K 80	3		
GKL-S-100 PTE/K AX	7		
GKL-S-125 PTE/K 55	3		
GKL-S-125 PTE/K 80	3		
GKL-S-125 PTE/K AX	7		
GKL-S-75 PTE/K 80-G2	3		
GKL-S-75 PTE/K A	7		
GKR-J-S-100 PTE/K 55	5		
GKR-J-S-100 PTE/K 80	5		
GKR-J-S-125 PTE/K 55	5		
GKR-J-S-125 PTE/K 80	5		
GKR-J-S-75 PTE/K 80-G2	5		
GKR-JY-S-100 PTE/K AX	8		
GKR-JY-S-125 PTE/K AX	8		
GKR-JY-S-75 PTE/K A	8		
GKR-R-S-100 PTE/K 55	5		
GKR-R-S-100 PTE/K 80	5		
GKR-R-S-100 PTE/K AX	8		
GKR-R-S-125 PTE/K 55	5		
GKR-R-S-125 PTE/K 80	5		
GKR-R-S-125 PTE/K AX	8		
GKR-R-S-75 PTE/K 80-G2	5		
GKR-R-S-75 PTE/K A	8		
GKR-S-100 PTE/K 55	5		
GKR-S-100 PTE/K 80	5		
GKR-S-100 PTE/K AX	8		



# also available



VARLEY

## LOW LEVEL CASTORS



## JACKING CASTOR



## ADJUSTABLE FOOT CASTOR

**CARRYMASTER®**



## GATE CASTOR



## FURNITURE CASTORS

**robby**



## SCAFFOLD CASTORS



## MEDICAL CASTORS

**manner**



## PALLET TRUCK ROLLERS



## TRACK WHEELS



## WIDE TREAD WHEELS



## TURNTABLES & SLEWING RINGS



## WHEELIE BIN WHEELS



## PALLET TRUCK STEER WHEELS



## BALL TRANSFER UNITS



## CONVEYING EQUIPMENT

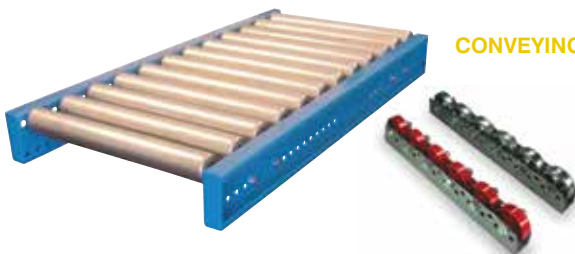

## ROTATING BUFFER



## ADJUSTABLE FOOT



## TRUCK LOCK



## CARGO CASTORS



## GLASS MOVING CASTOR







# VARLEY

## H VARLEY LIMITED

[www.varley-castors.co.uk](http://www.varley-castors.co.uk)

### Head Office, Warehouse

5 Century Park | Pacific Road | Broadheath | Altrincham | Cheshire | WA14 5BJ  
t 0161 928 9617 | f 0161 928 7824 | e [sales@varley.co.uk](mailto:sales@varley.co.uk)

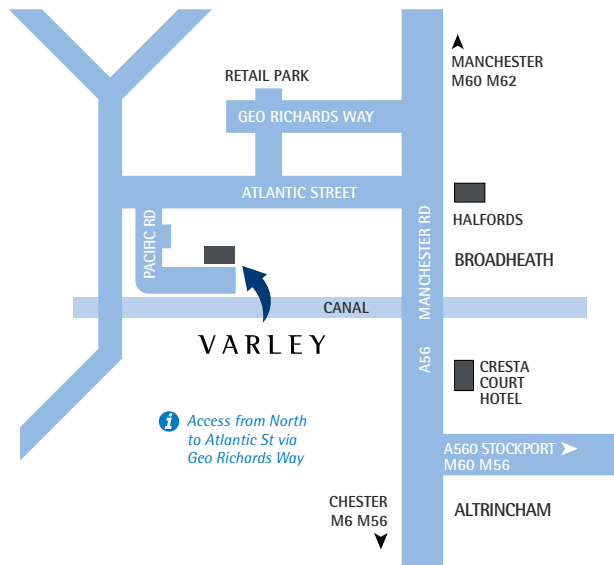

### Scotland, North East

t 01698 732523 | f 01698 730947 | e [scotsales@varley.co.uk](mailto:scotsales@varley.co.uk)

### Midlands, South

t 01952 462527 | f 01952 460176 | e [midsales@varley.co.uk](mailto:midsales@varley.co.uk)



10803

1938  
EIGHTY YEARS  
2018